

EVOTECH®
P E R F O R M A N C E

www.evotech-performance.com

Aprilia RS660 Tail Tidy
Installation Instructions



Kit Contents PRN015278

- | | |
|-----------------------------------|-----------------------------------|
| (A) 1 x Reflector Kit | (M) 2 x M4 Flange Nuts |
| (B) 1 x Retro Light | (N) 2 x M6 Special Washer |
| (C) 1 x Light Bracket | (O) 2 x M6 x 40 Button Head Bolts |
| (D) 1 x Loom Connector | (P) 2 x M6 x 35 Caphead |
| (E) 1 x Number Plate Bracket | (Q) 2 x M6 x 60 Caphead |
| (F) 1 x Main Body Left | (R) 4 x Indicator Stems |
| (G) 1 x Main Body Right | (S) 4 x M6 x 12 Button Head Bolts |
| (H) 1 x Mounting Plate | (T) 4 x M4 x 10 Button Head Bolts |
| (I) 1 x Cover Plate | |
| (J) 1 x Special Spacer | |
| (K) 1 x M6 x 35 Button Head Bolts | |
| (L) 2 x M4 x 8 Button Head Bolts | |



BURTON-ON-TRENT
ARNOLDSMOTORCYCLES.COM

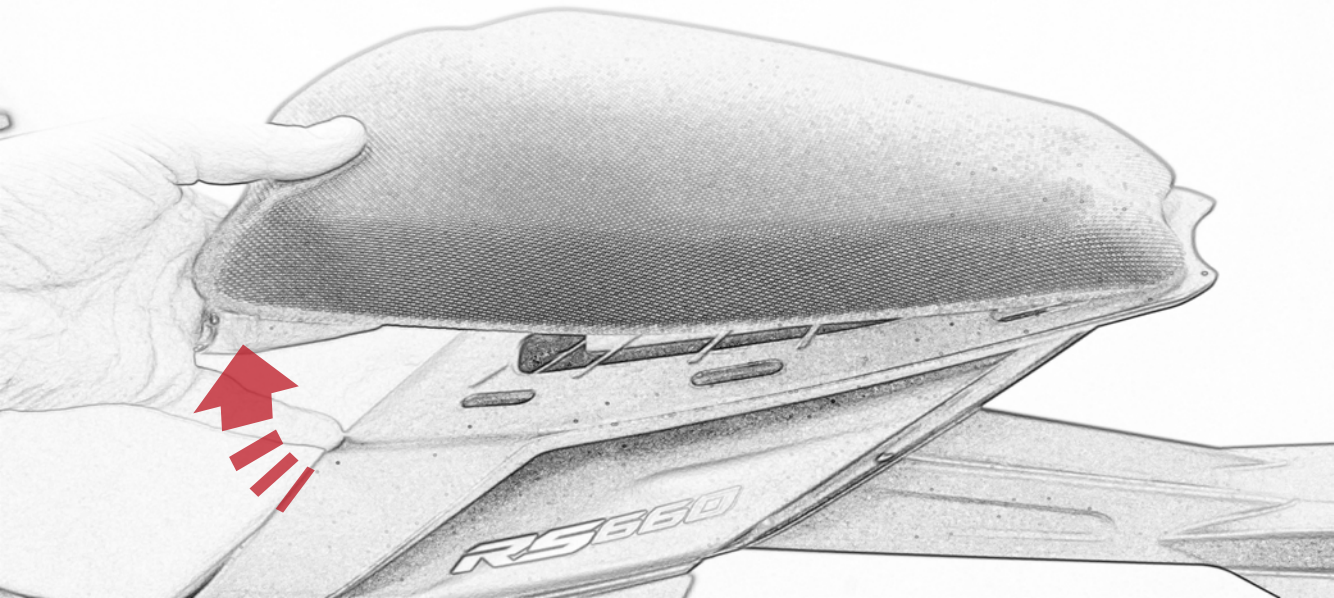

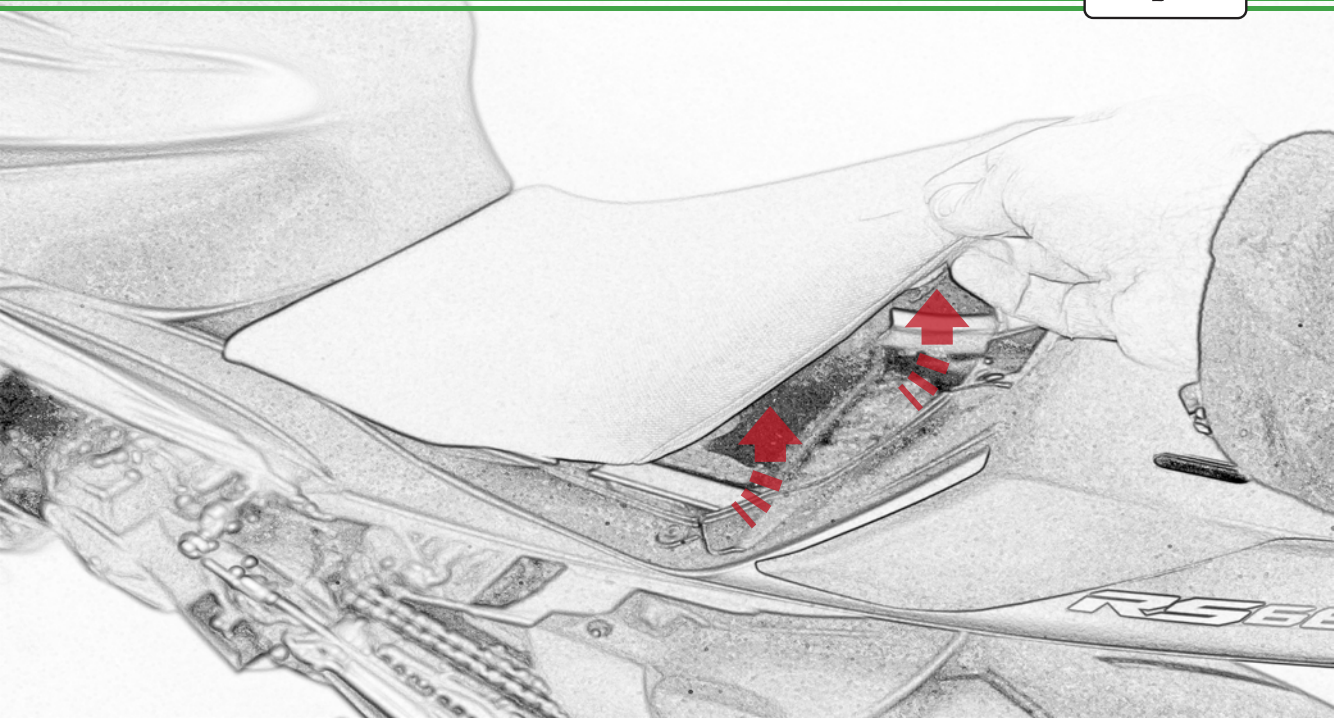

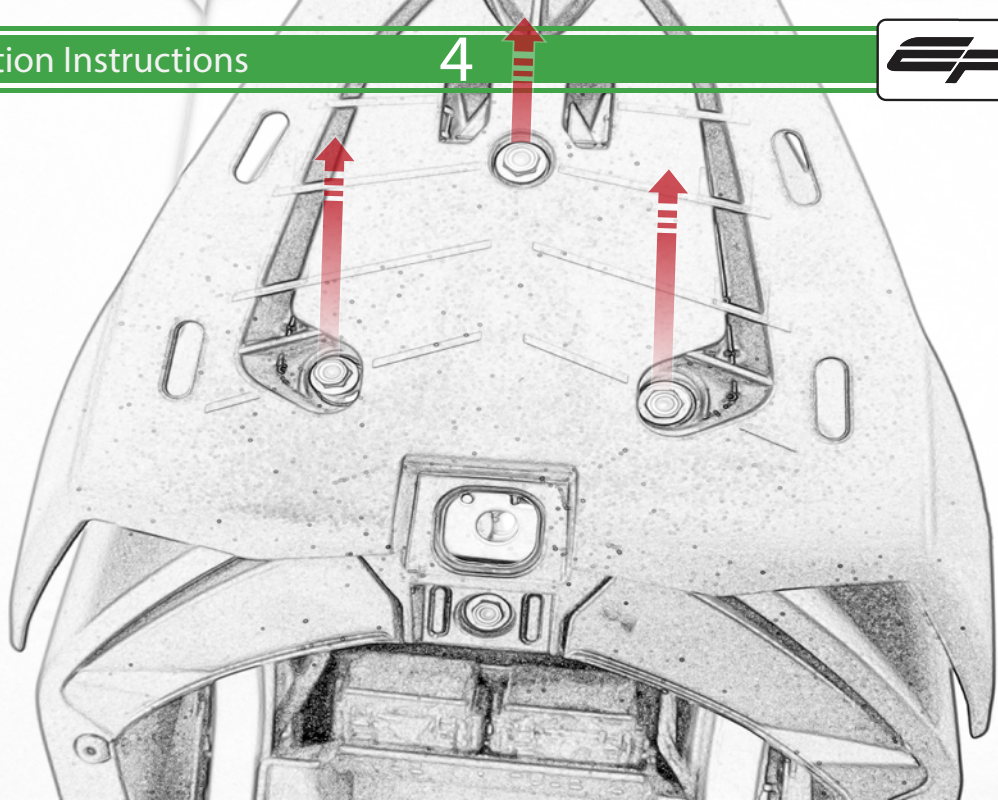

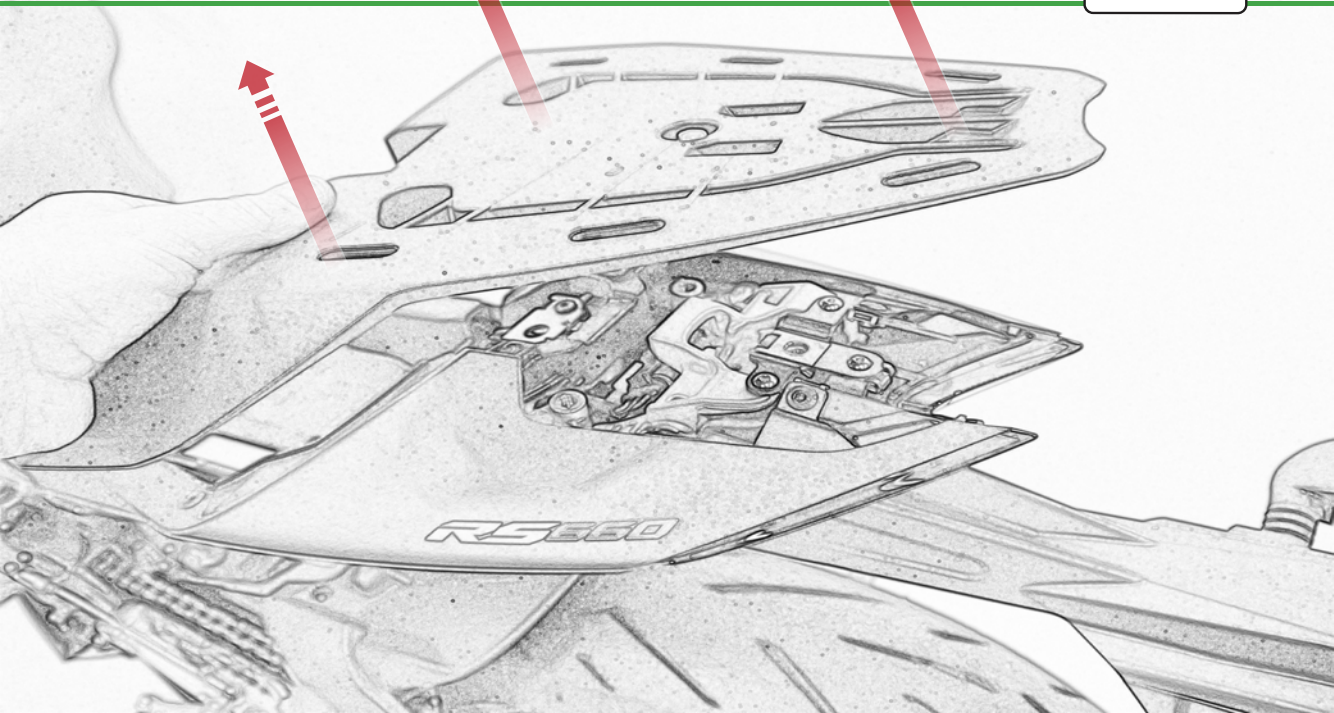

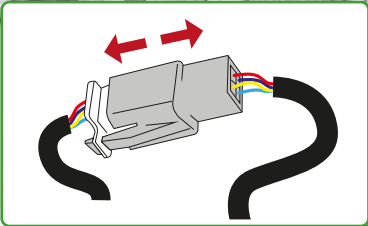
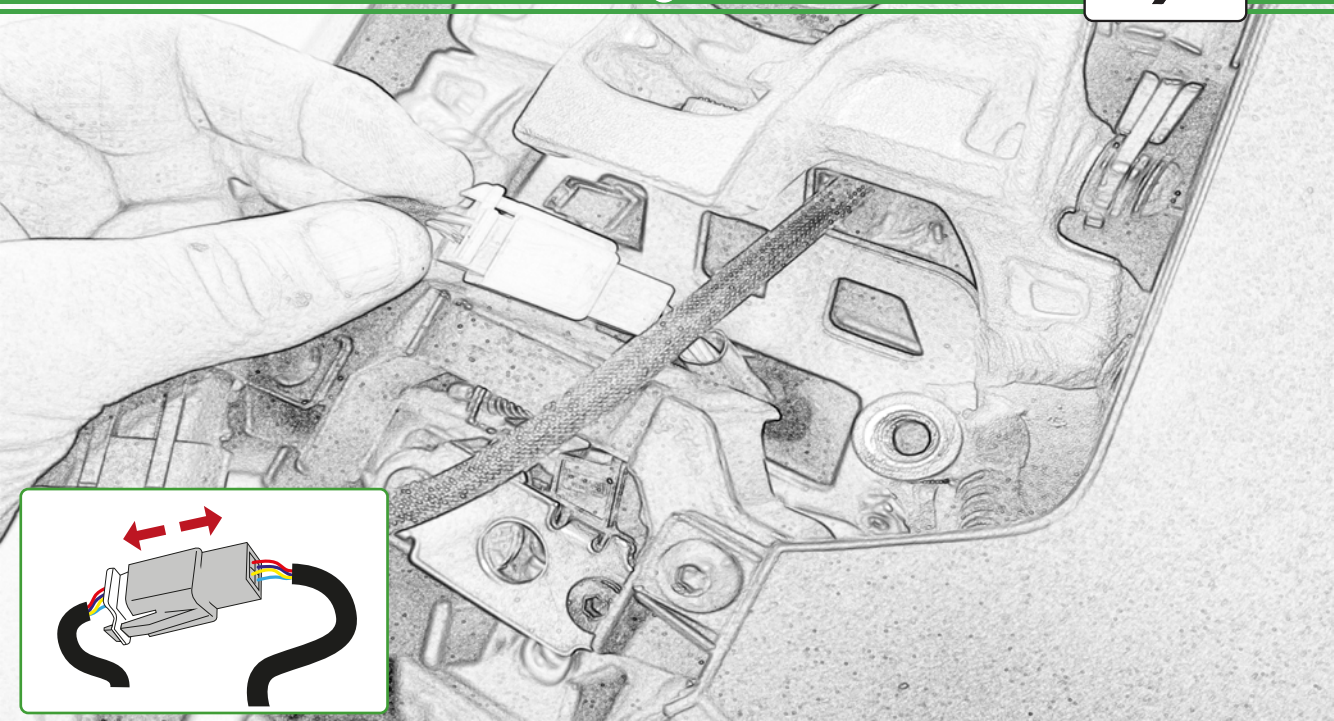

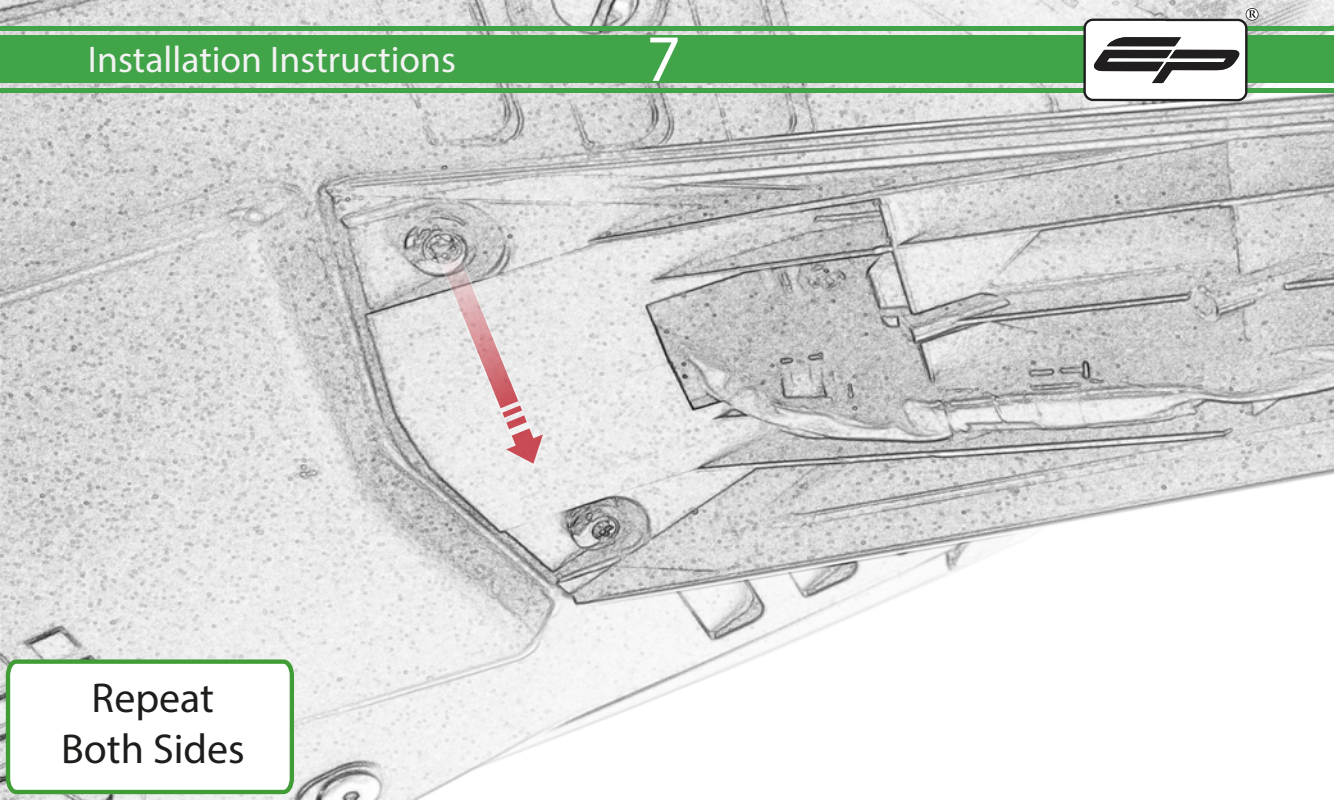

Repeat
Both Sides



Repeat
Both Sides

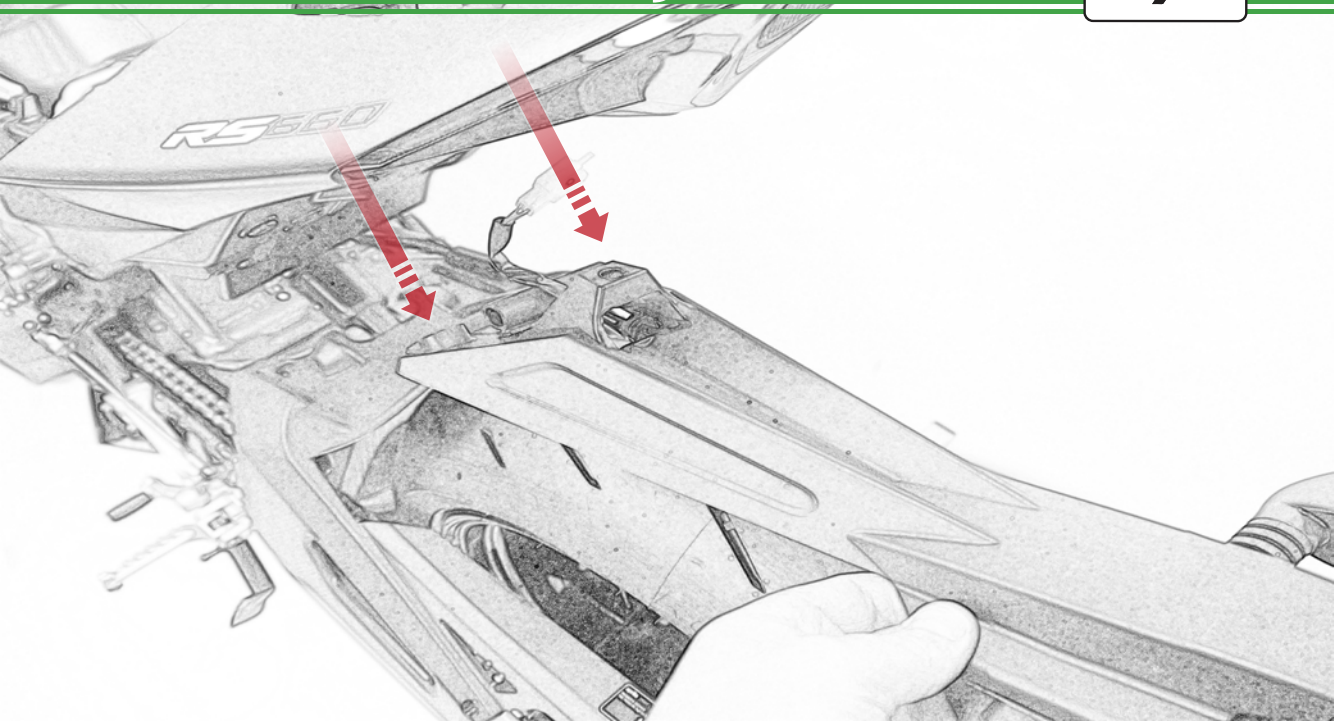

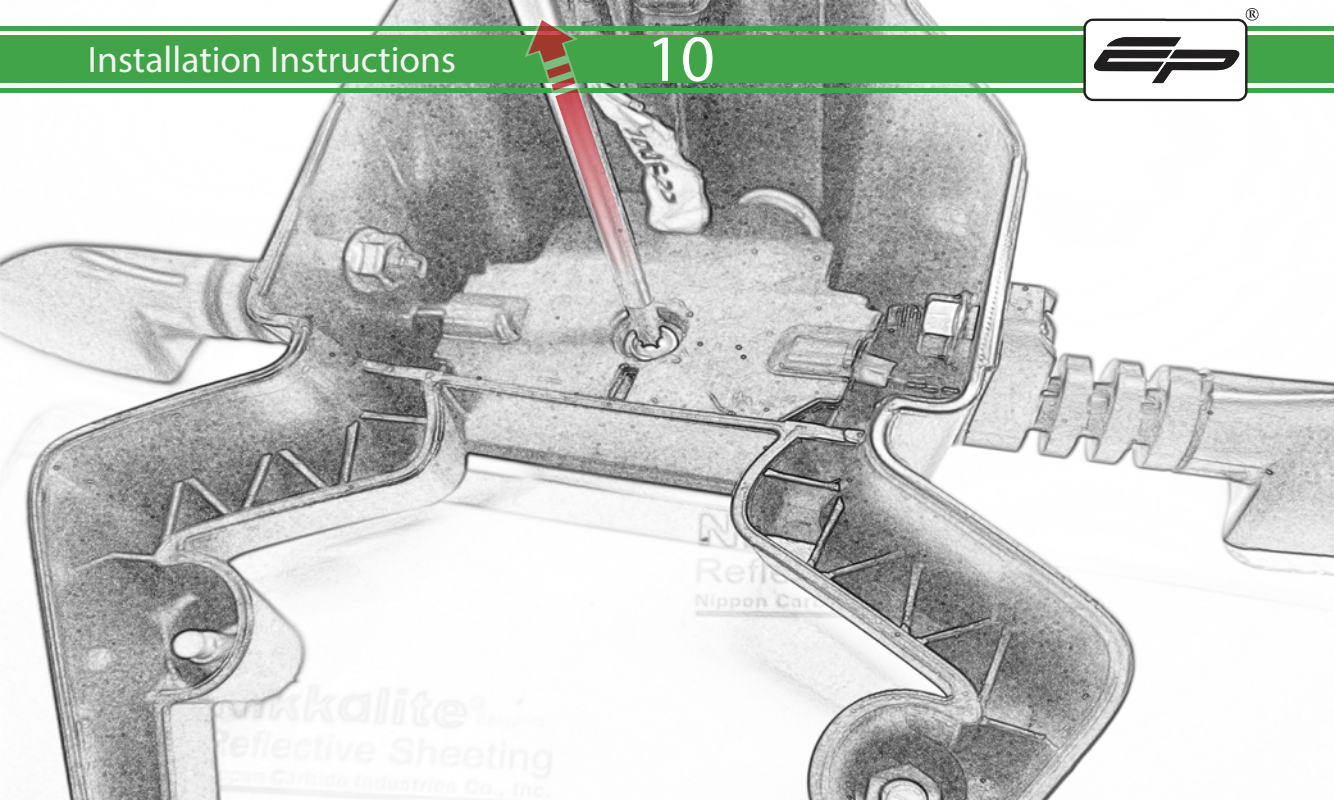

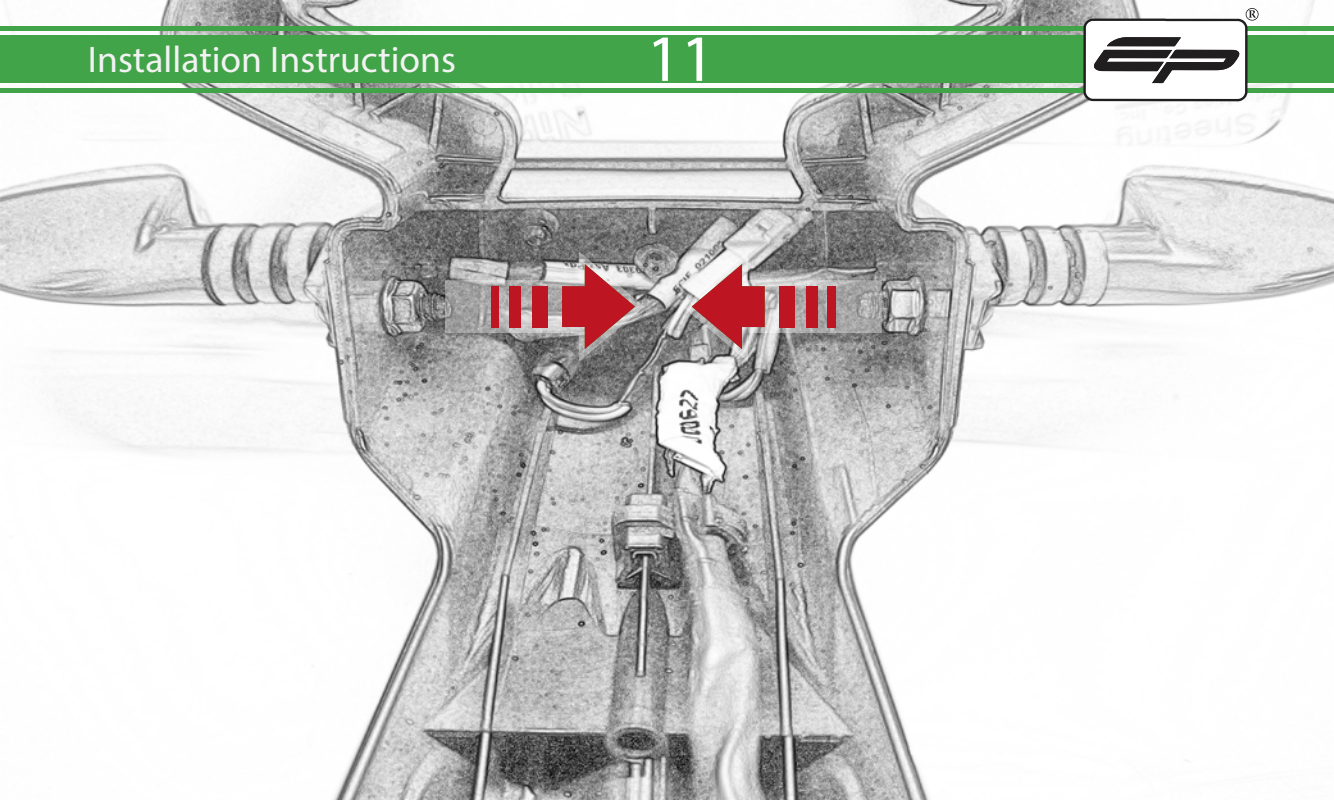

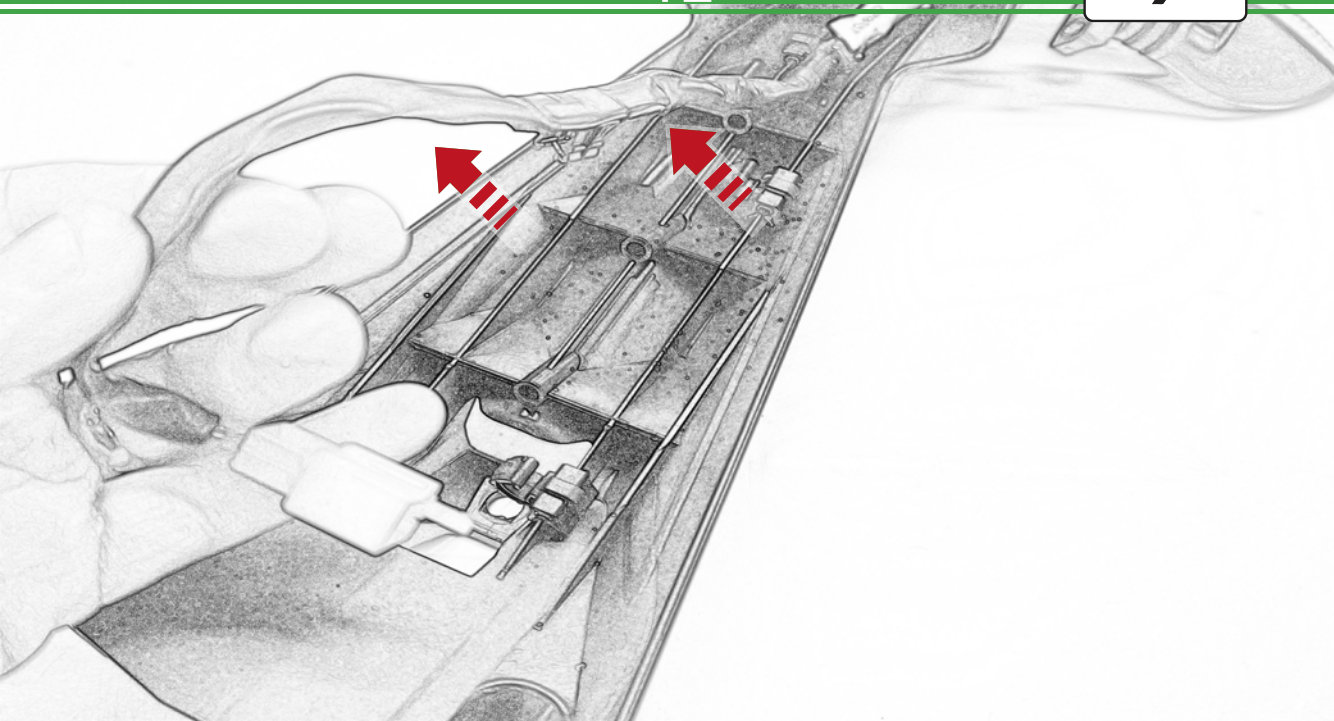

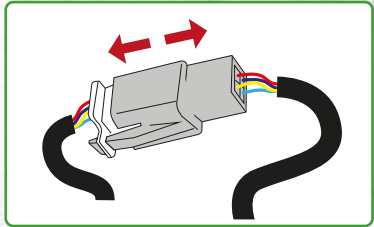
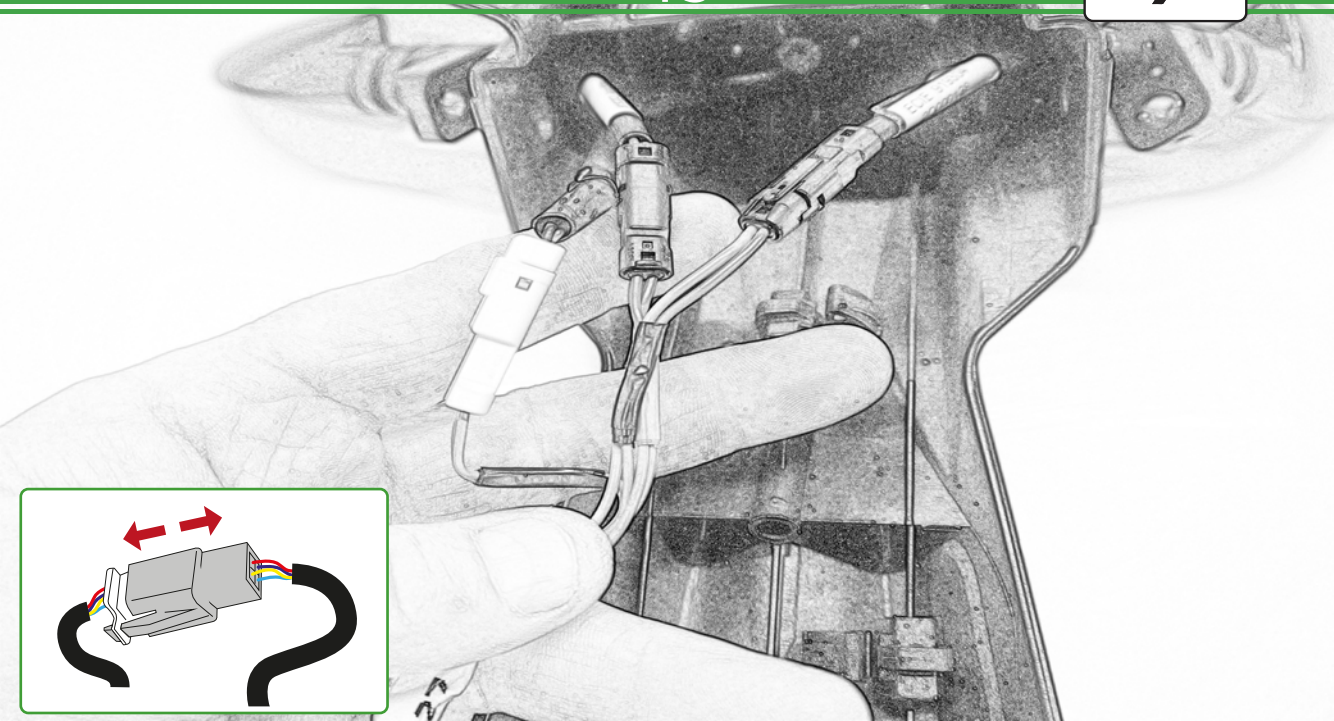

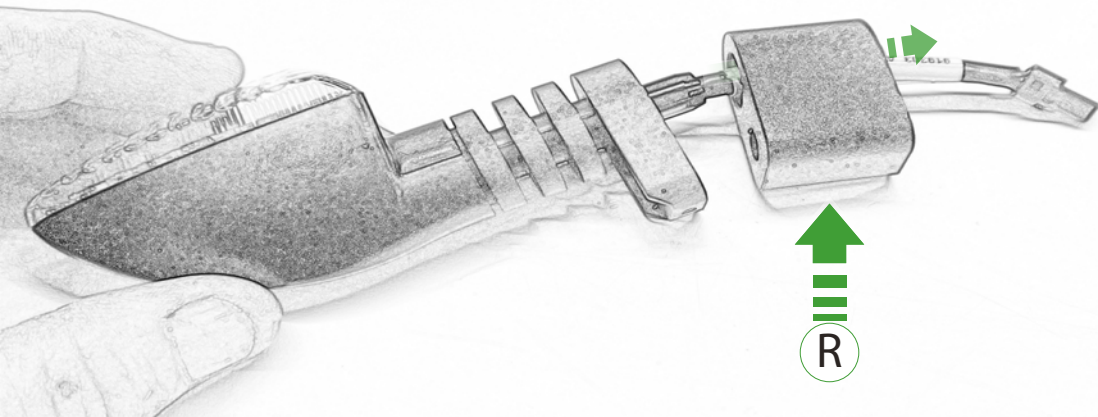



Repeat
Both Sides

 Use 2 x Part R and Q for wider
Indicator Position

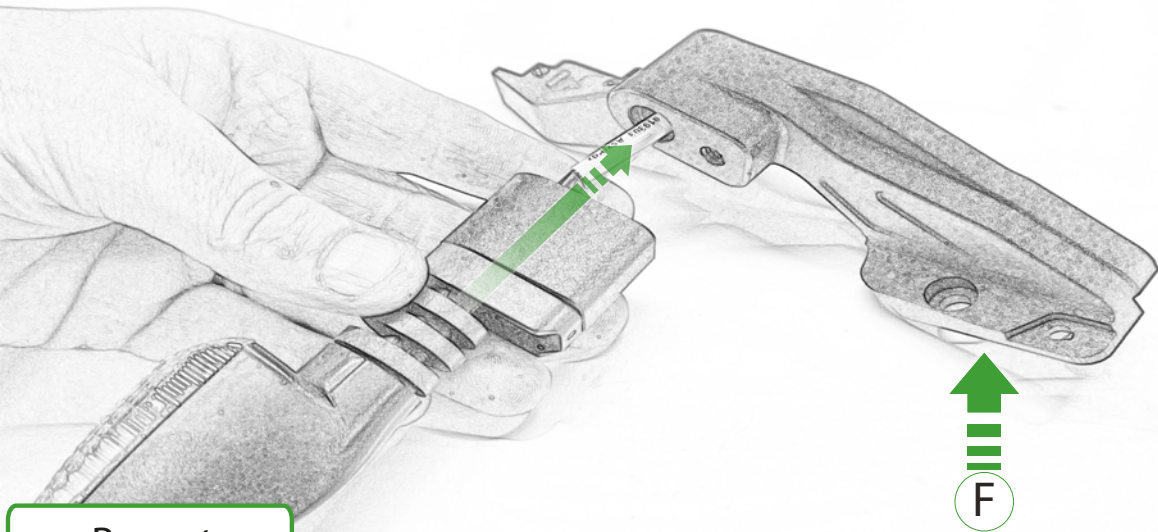

Repeat
Both Sides

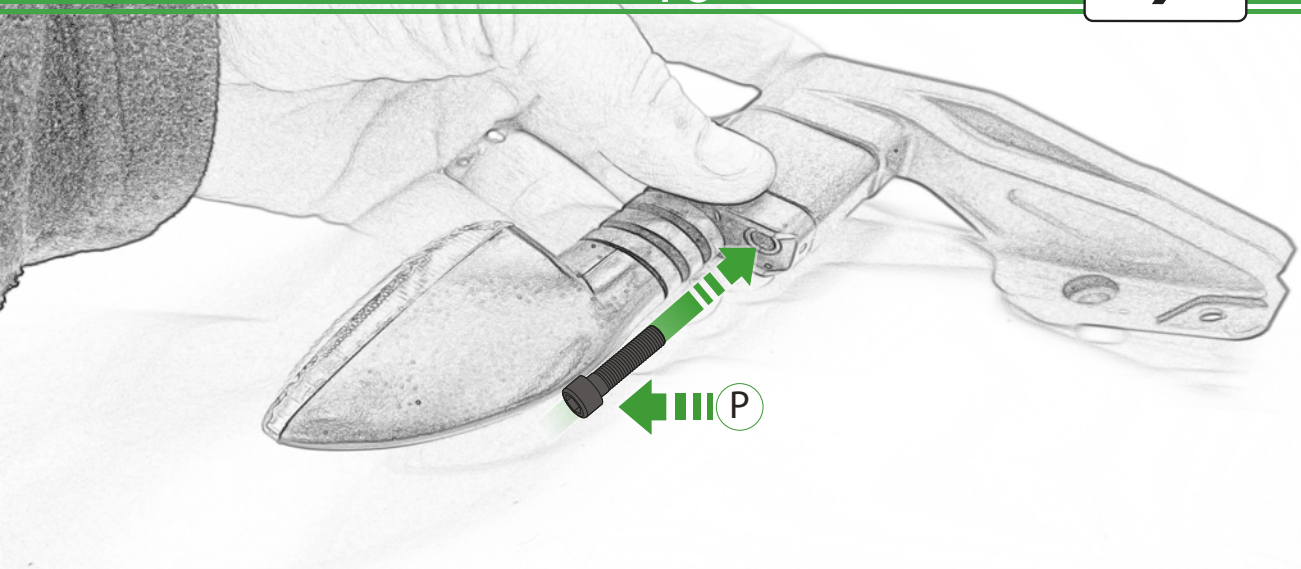

Repeat
Both Sides

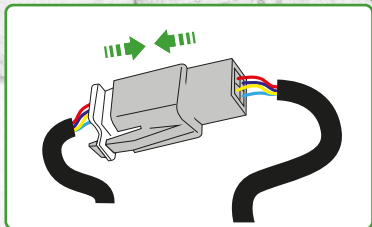
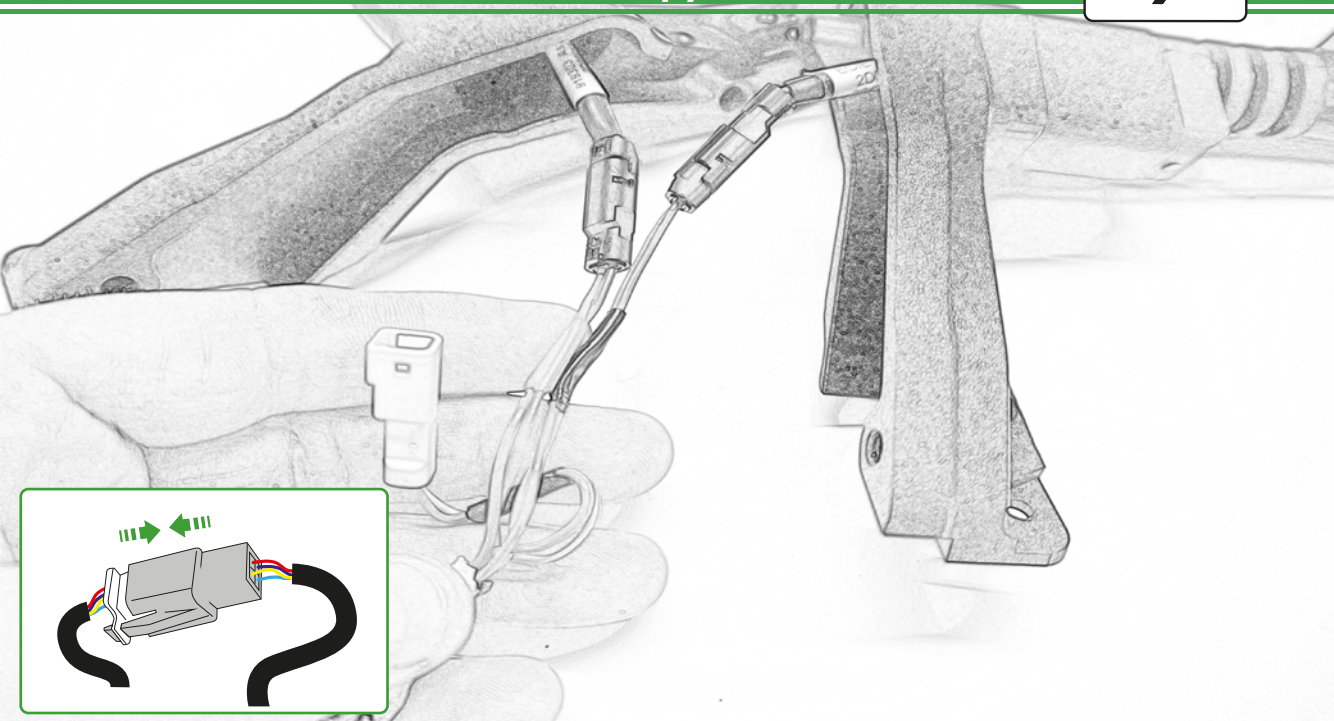

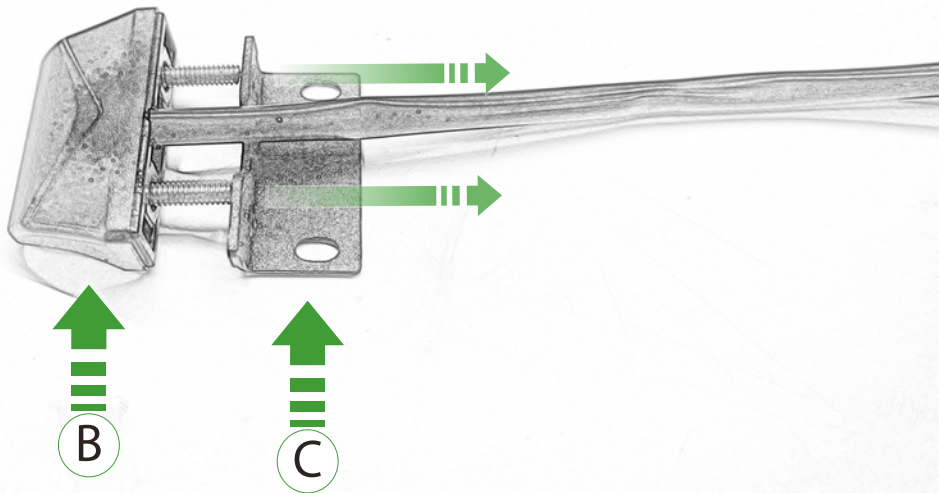

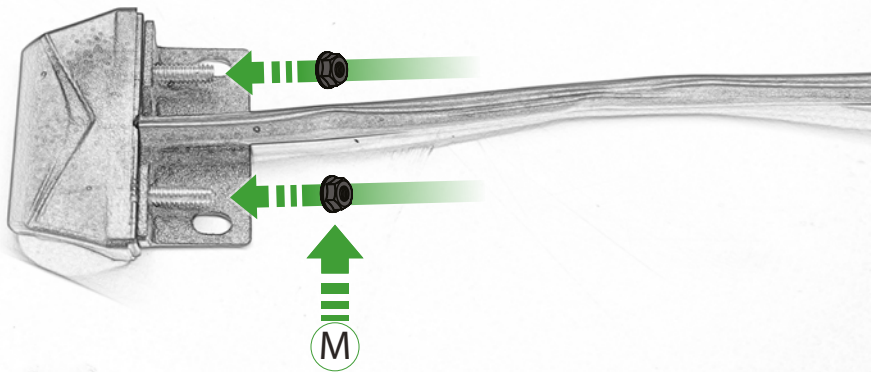

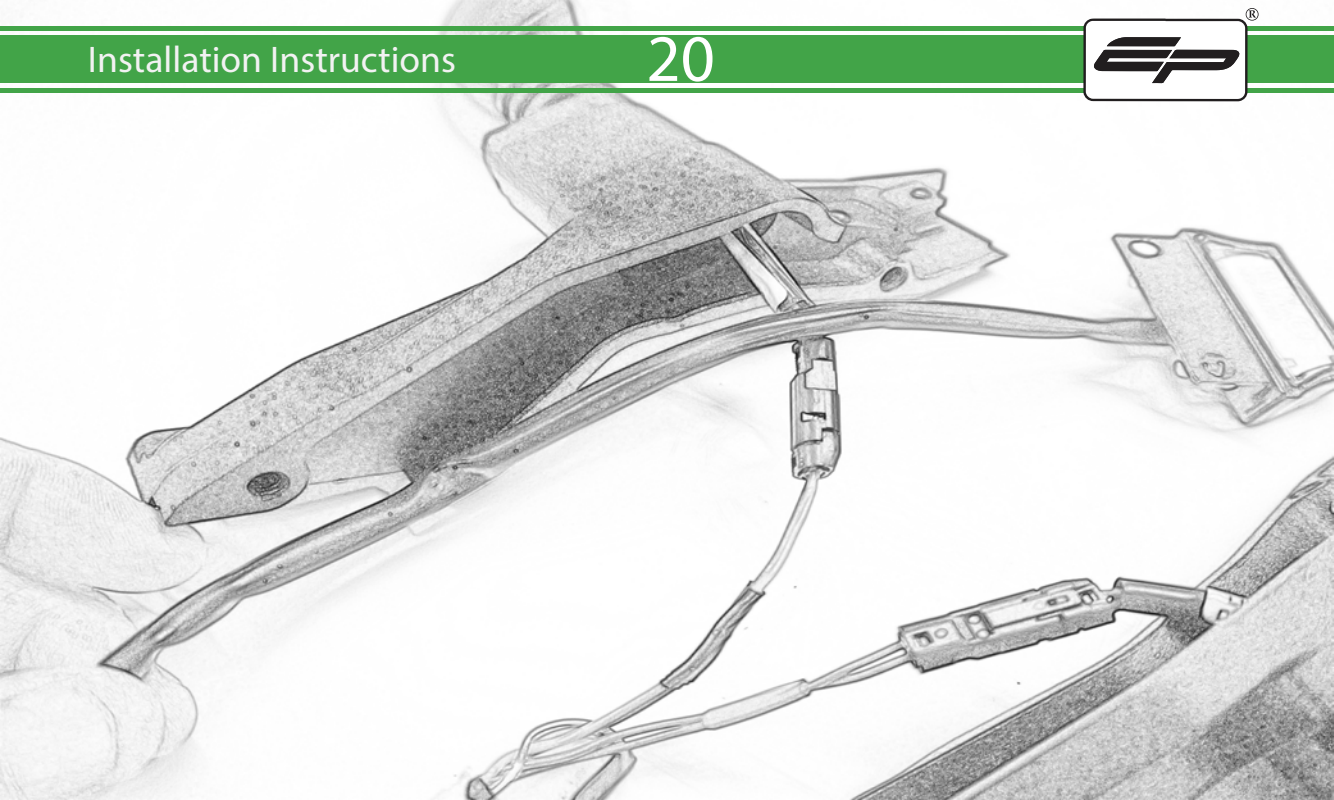

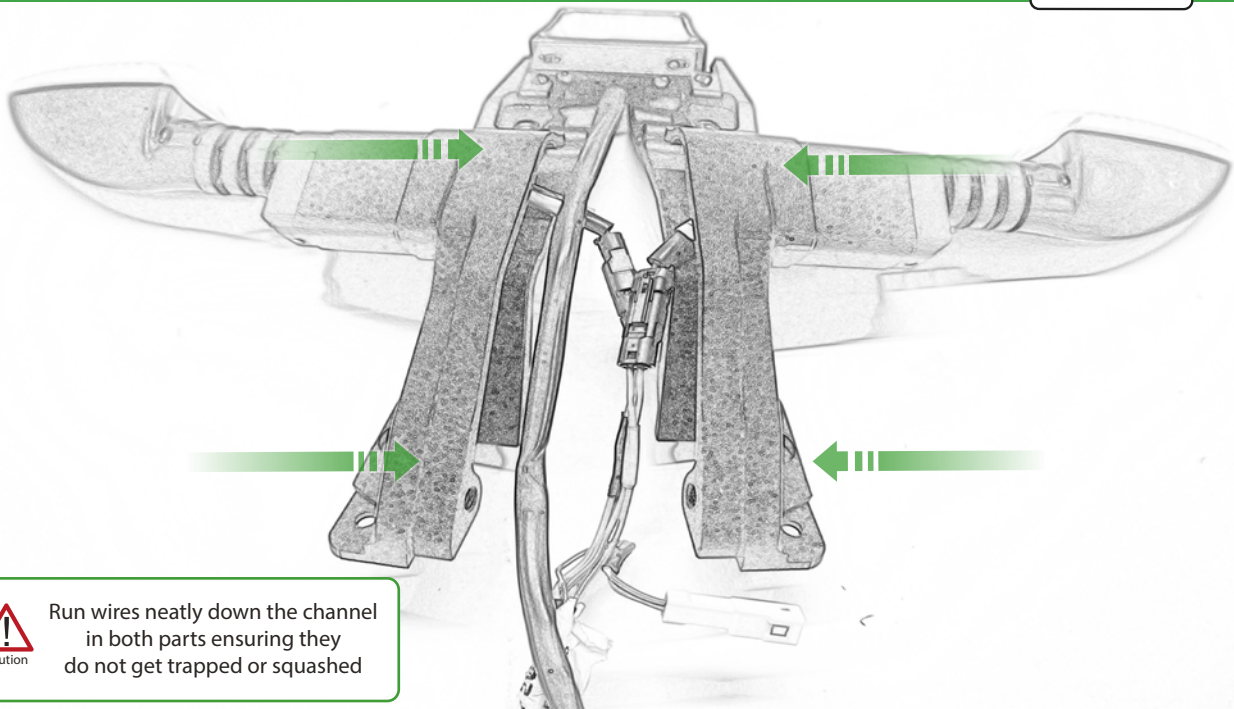

Caution

Run wires neatly down the channel in both parts ensuring they do not get trapped or squashed

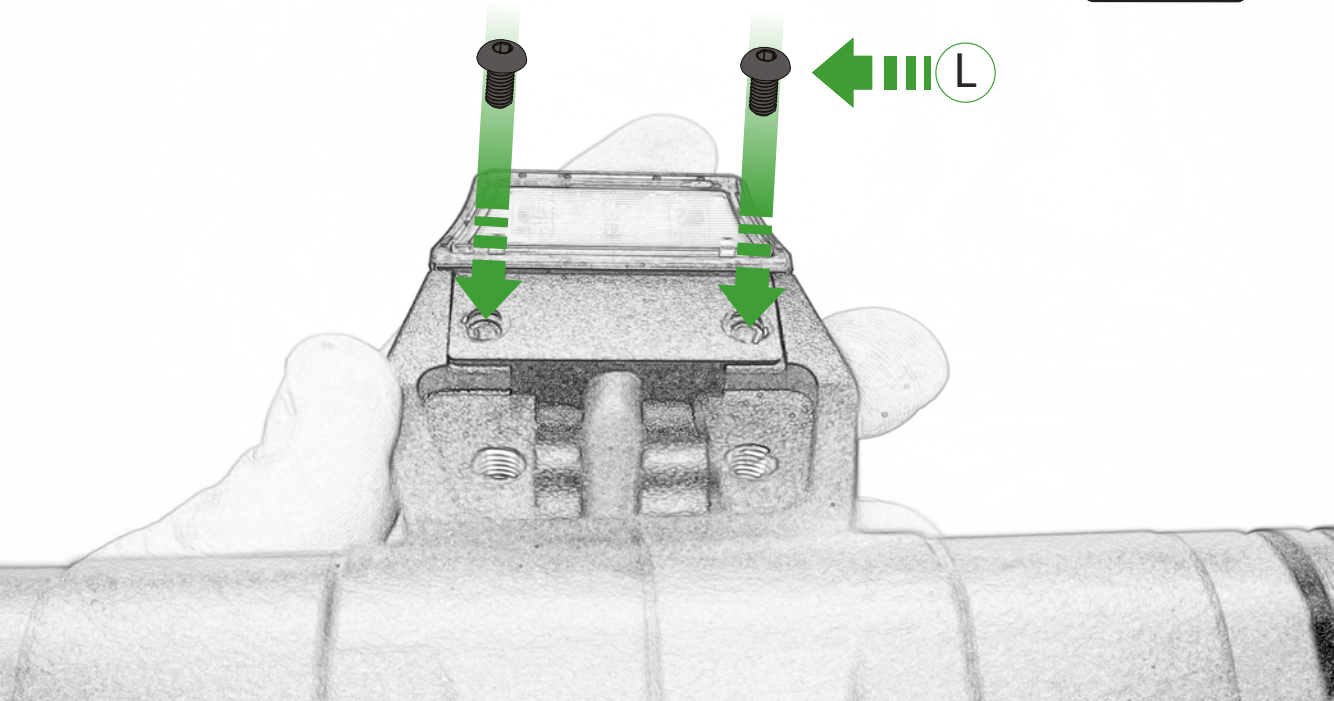

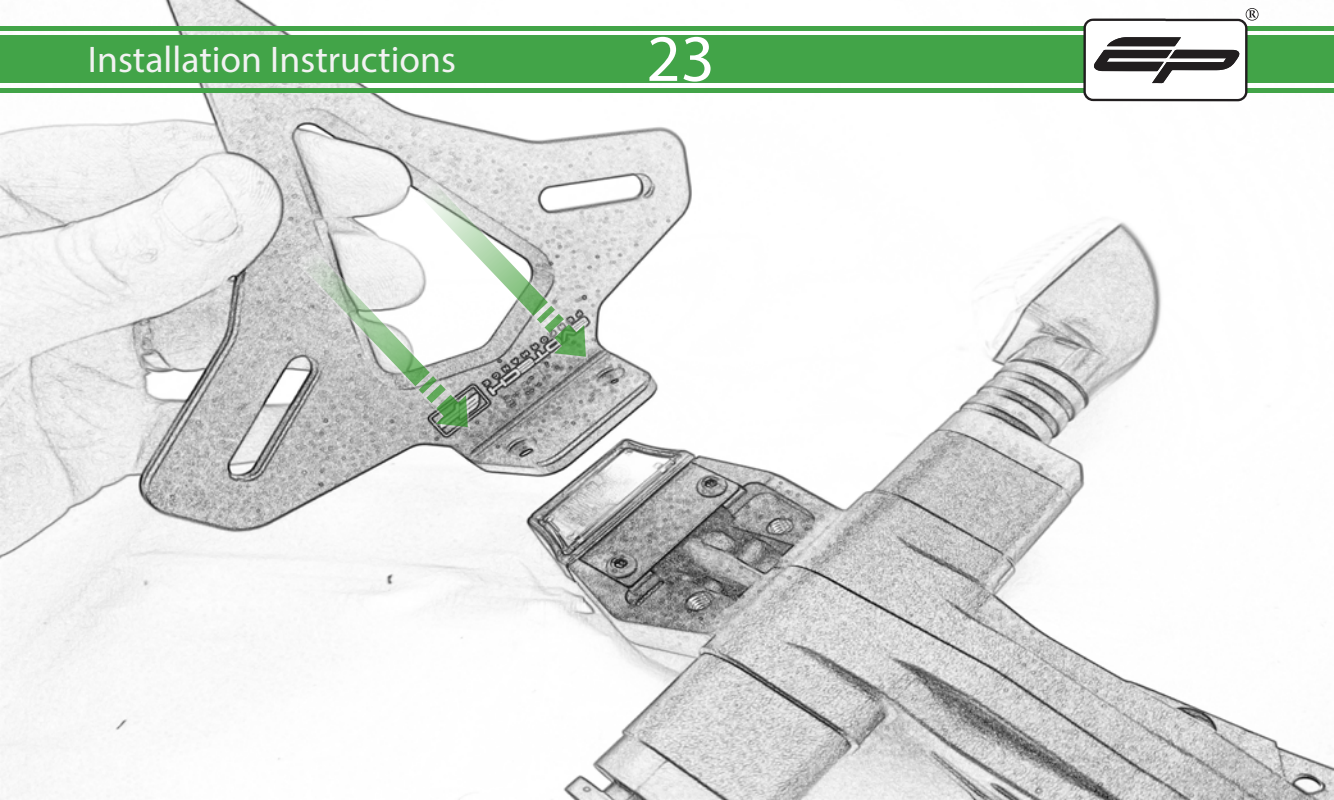

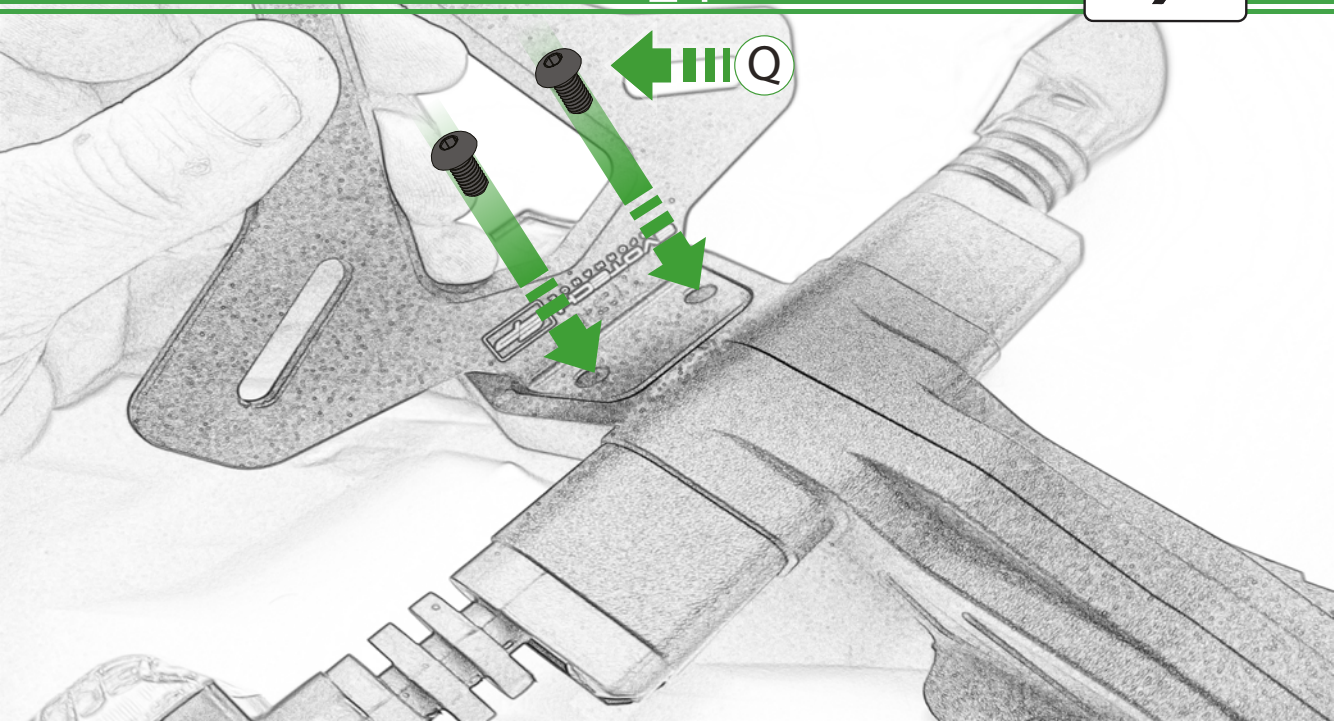

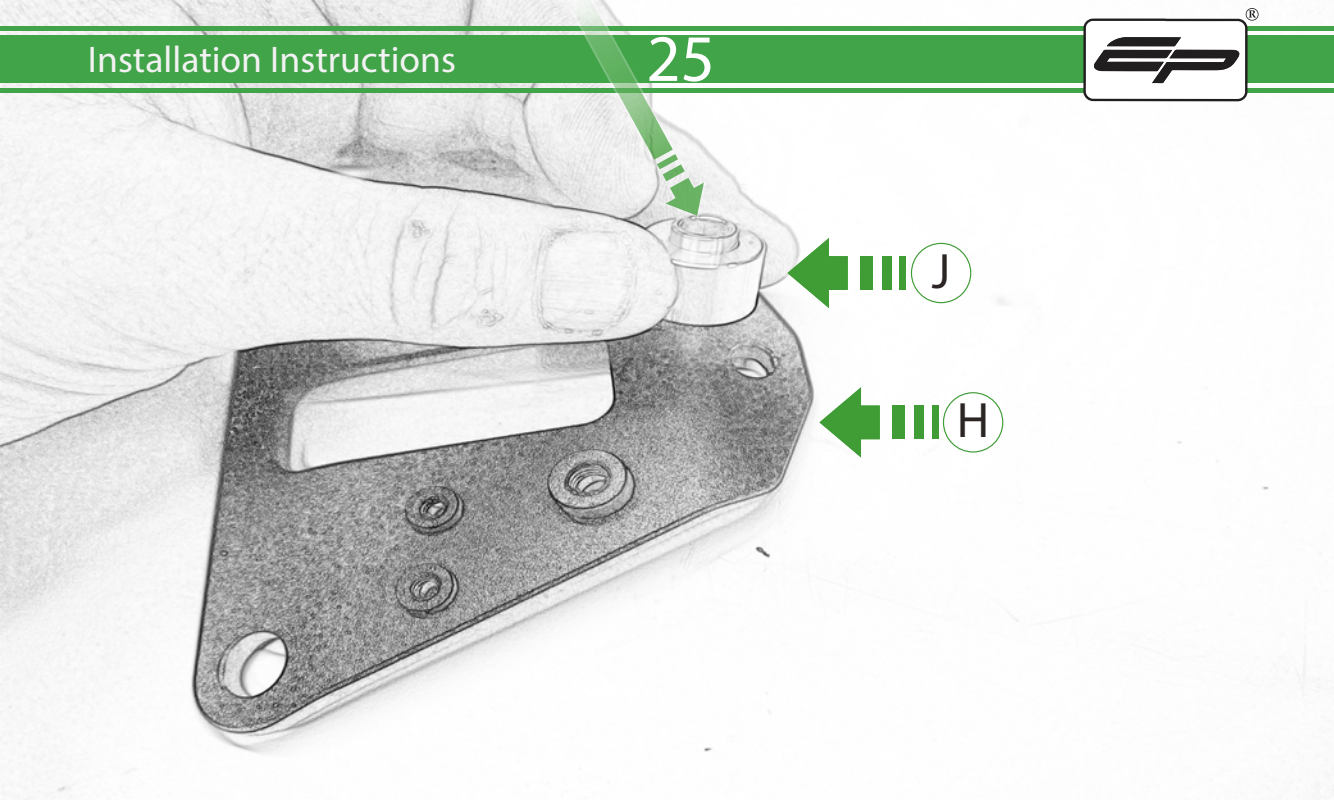

J

H

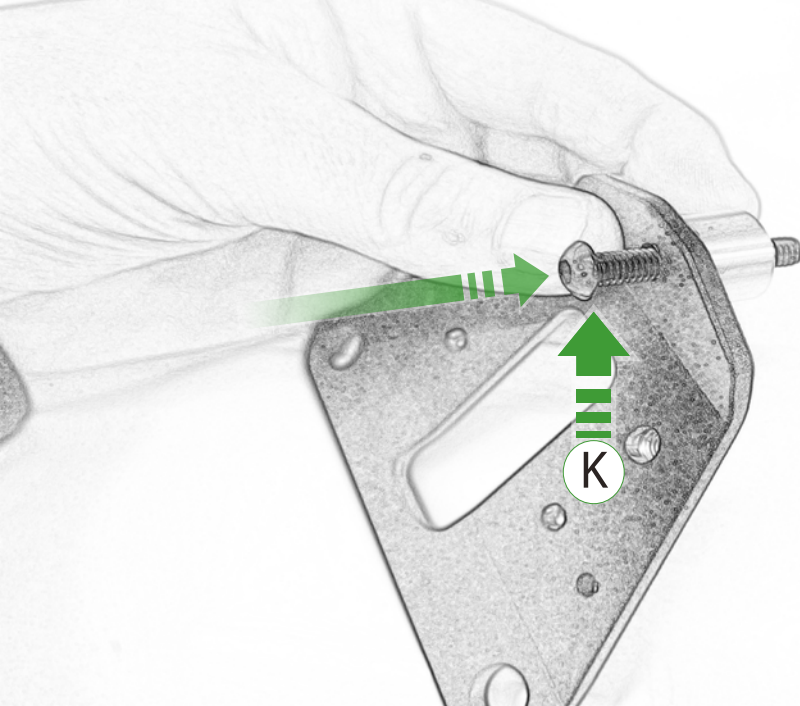

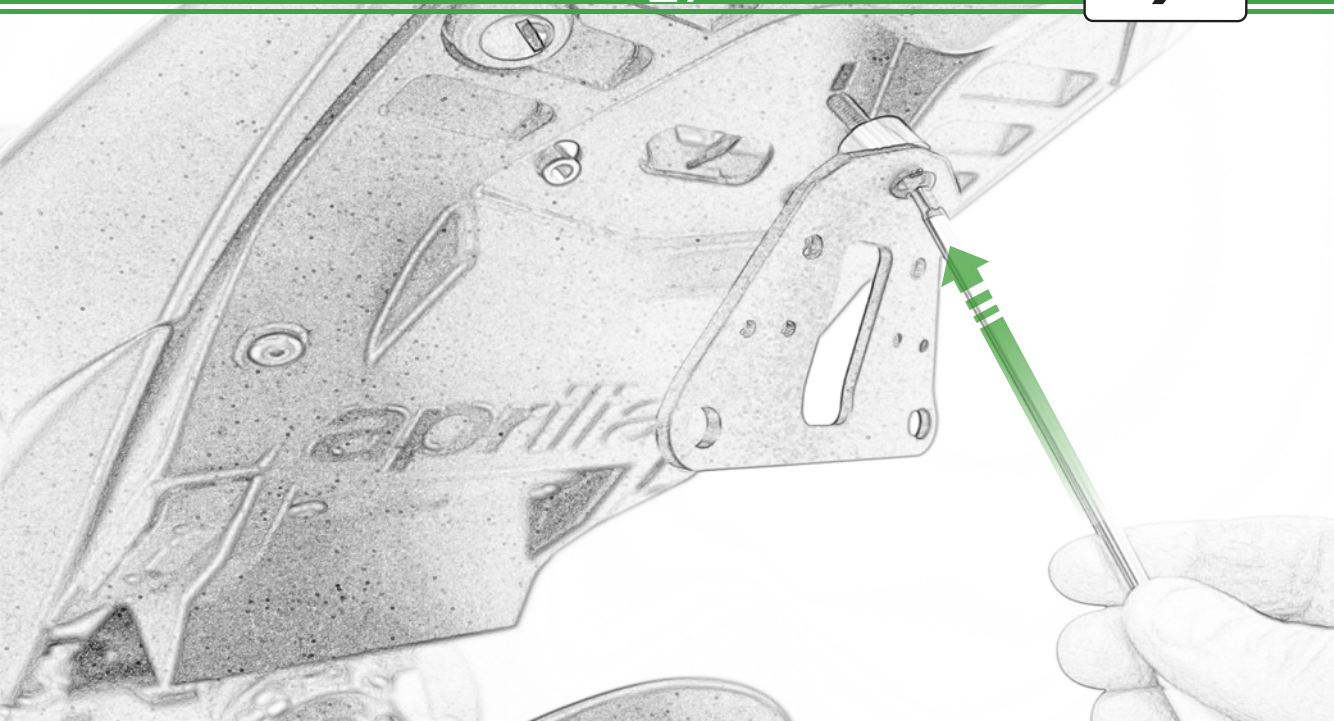



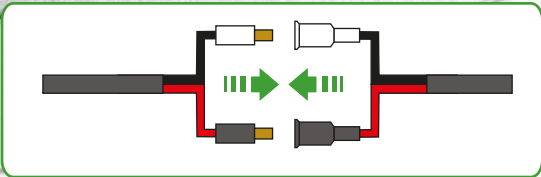
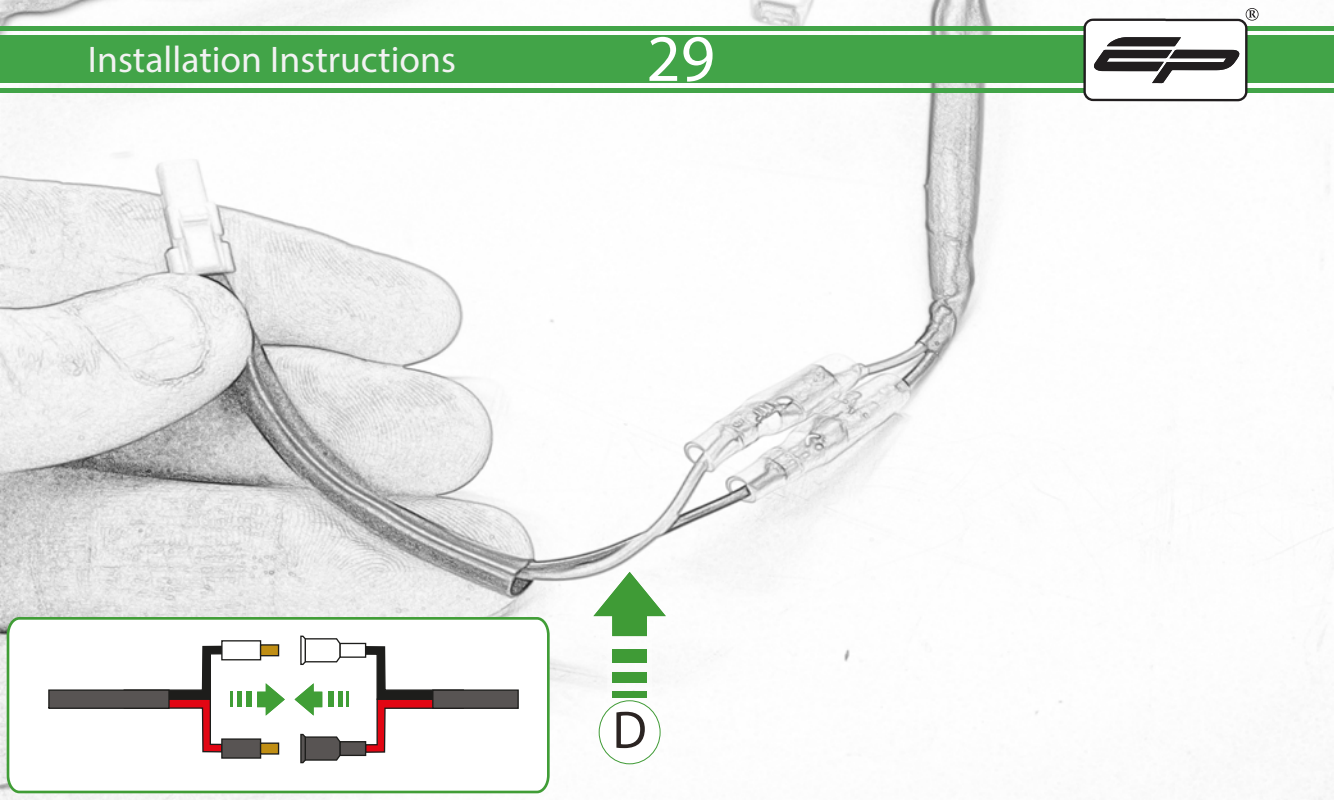

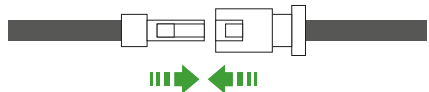
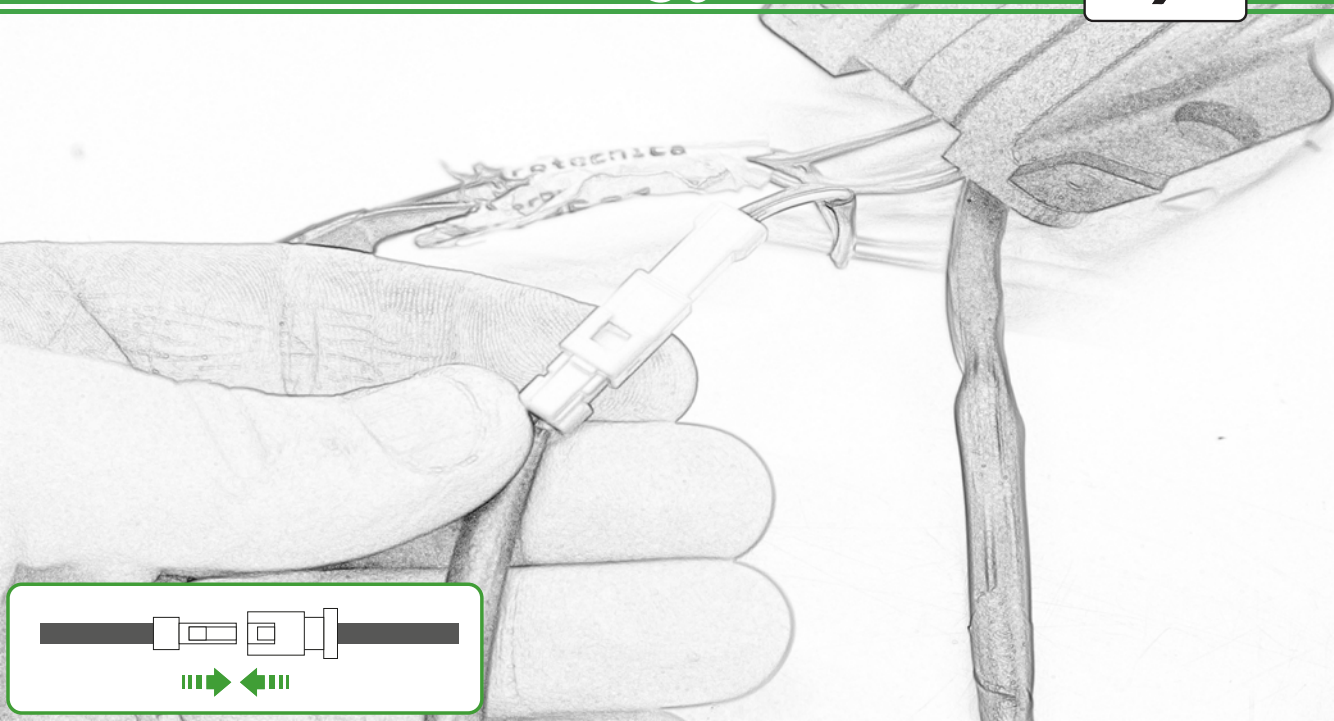

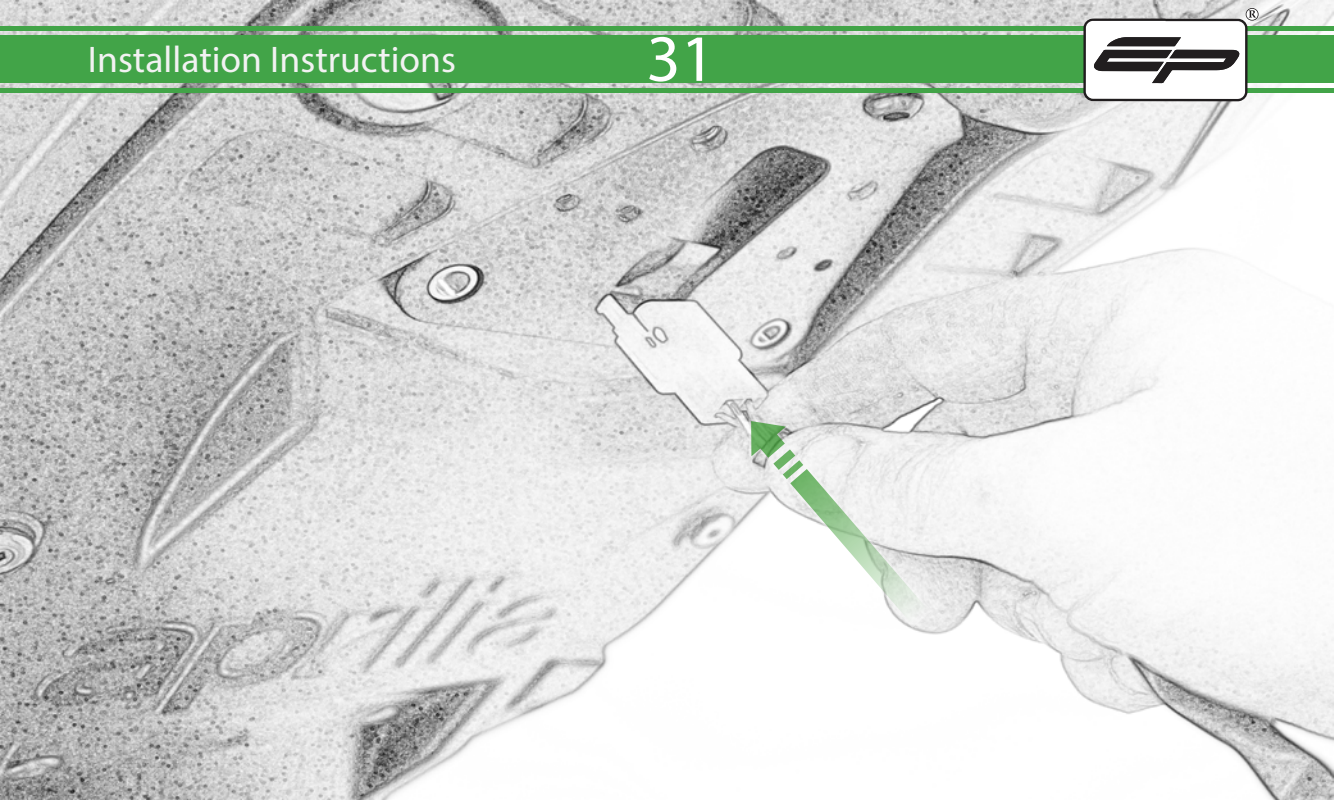

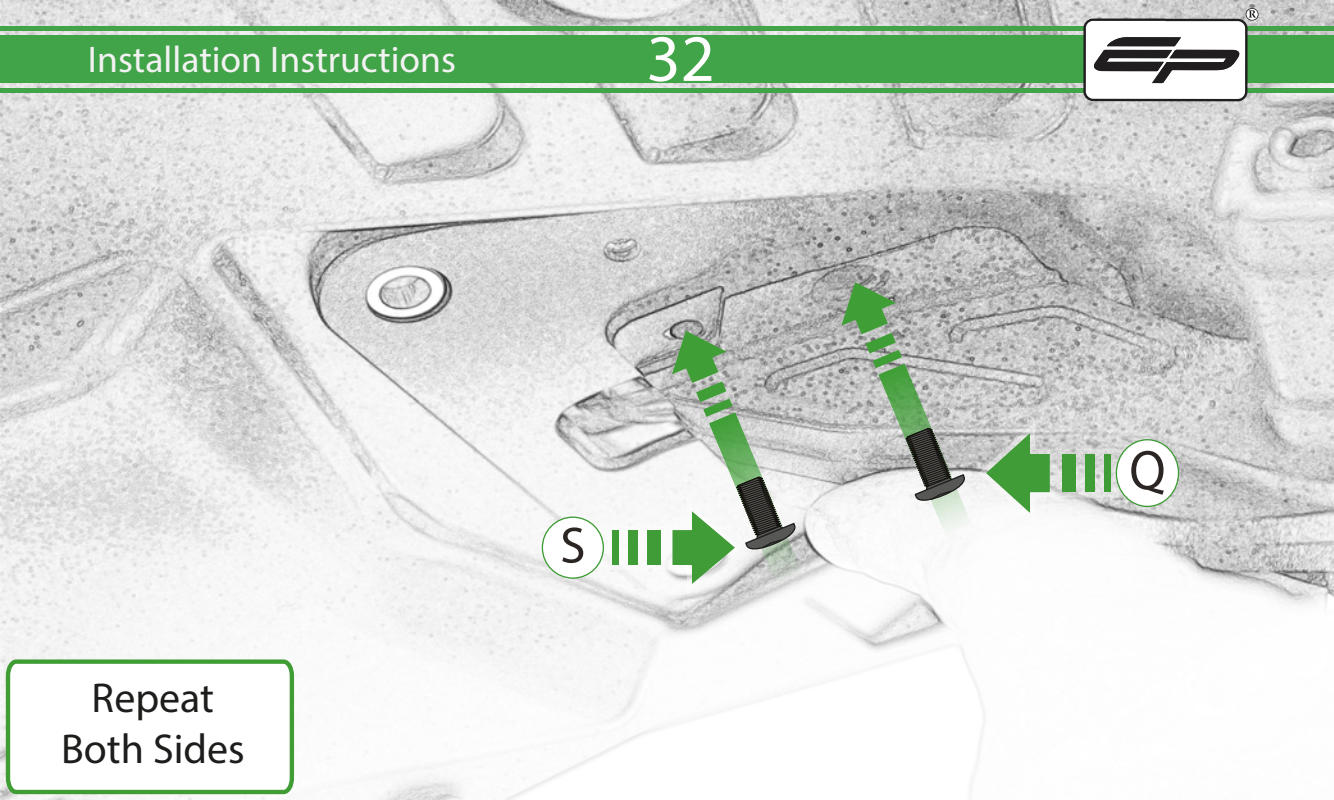

S

Q

Repeat
Both Sides

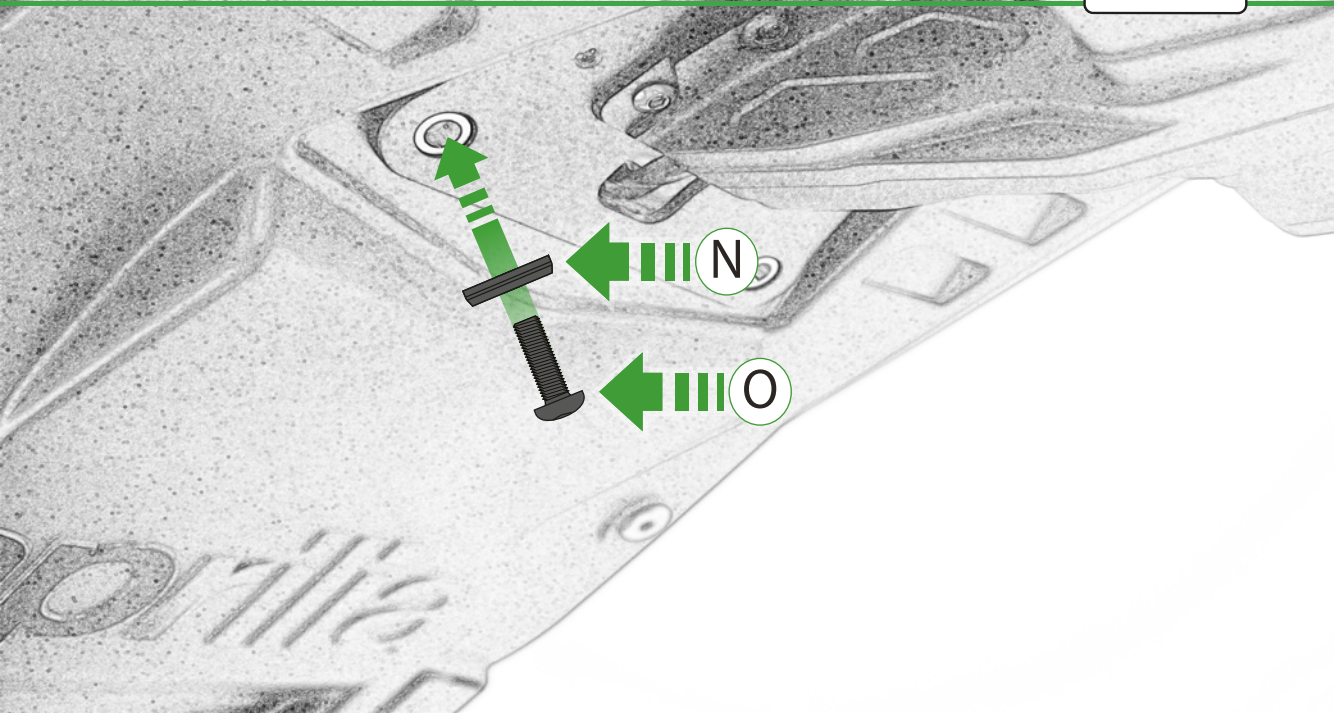

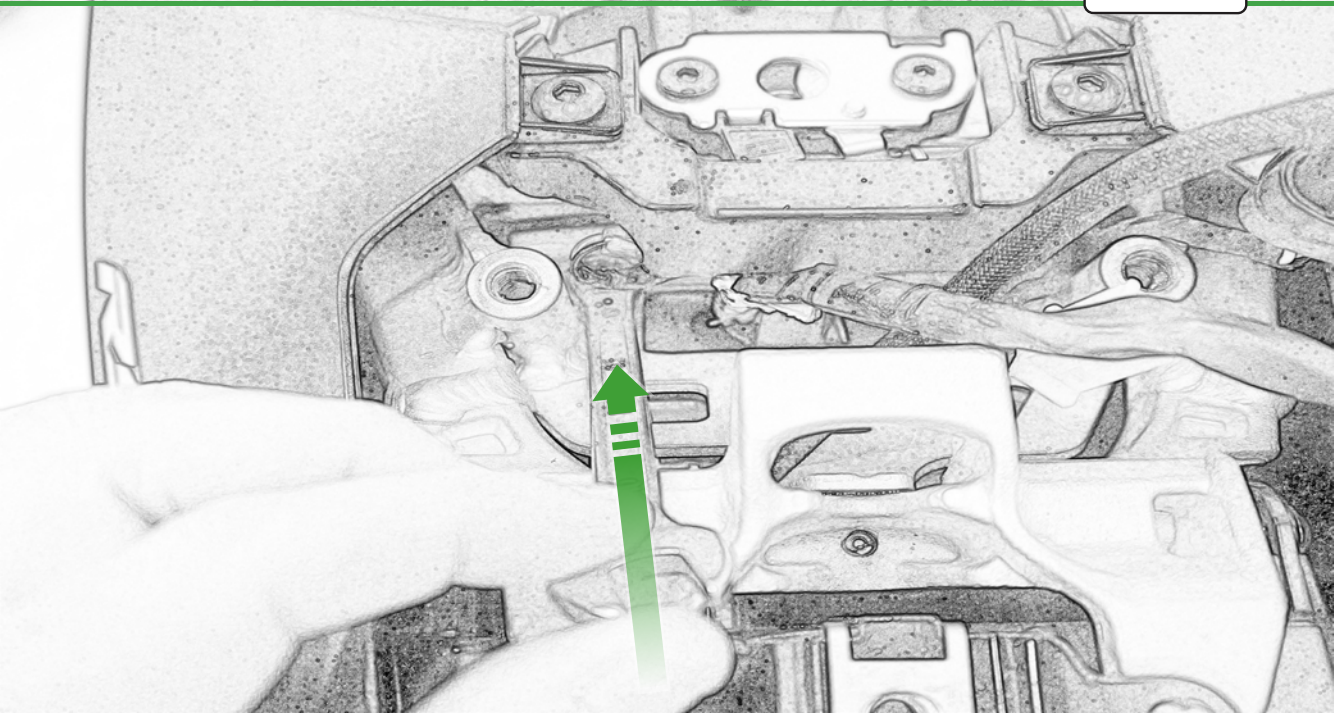

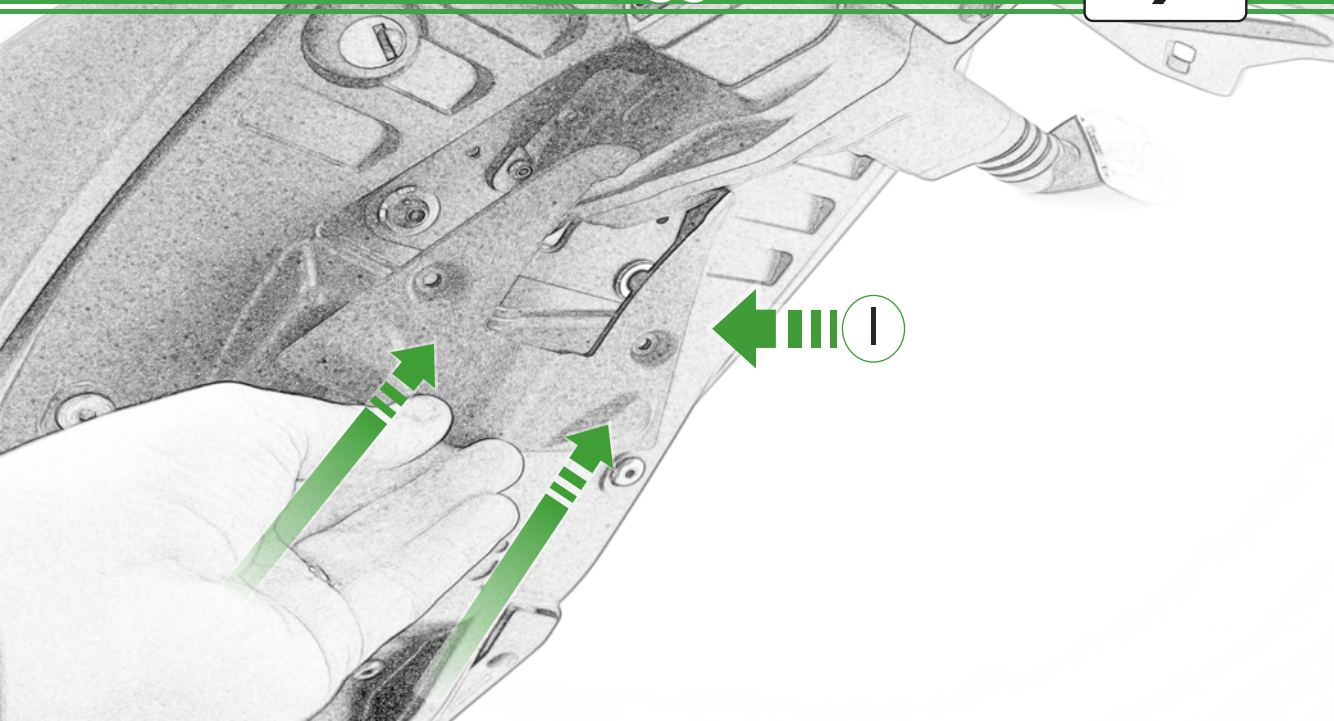



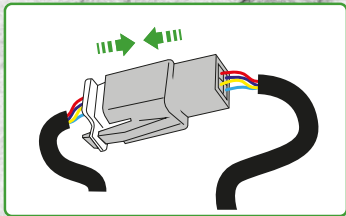
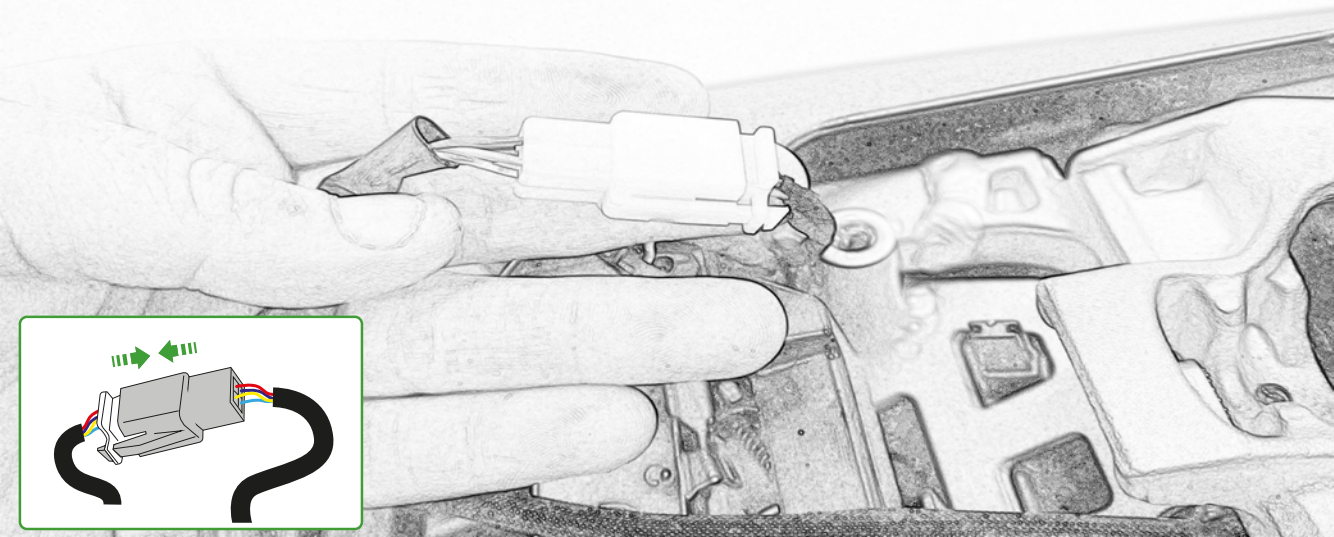

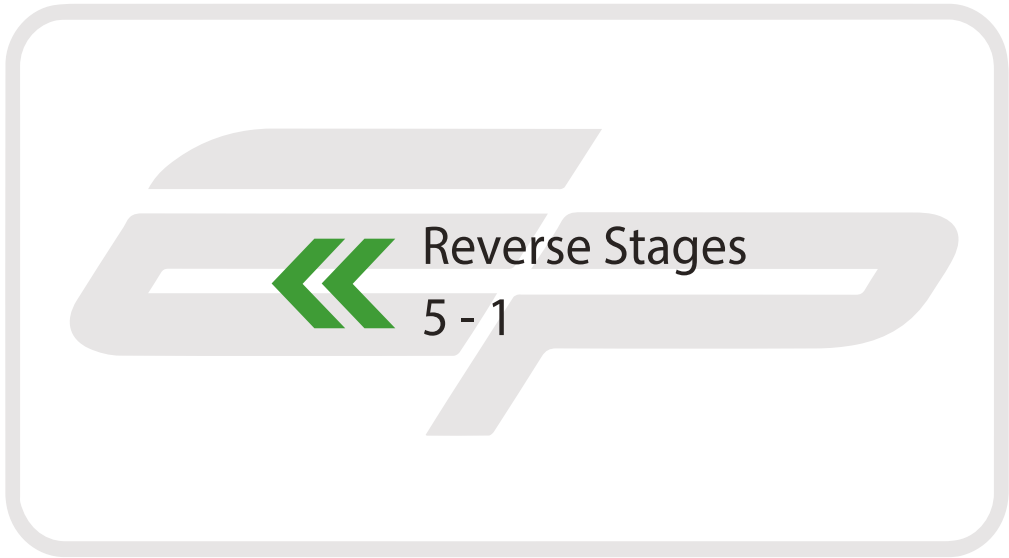

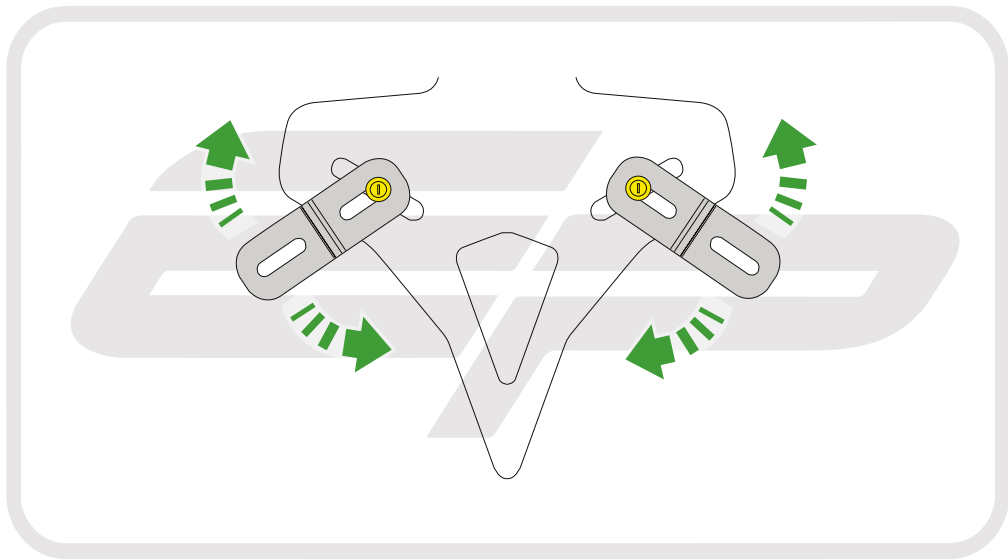

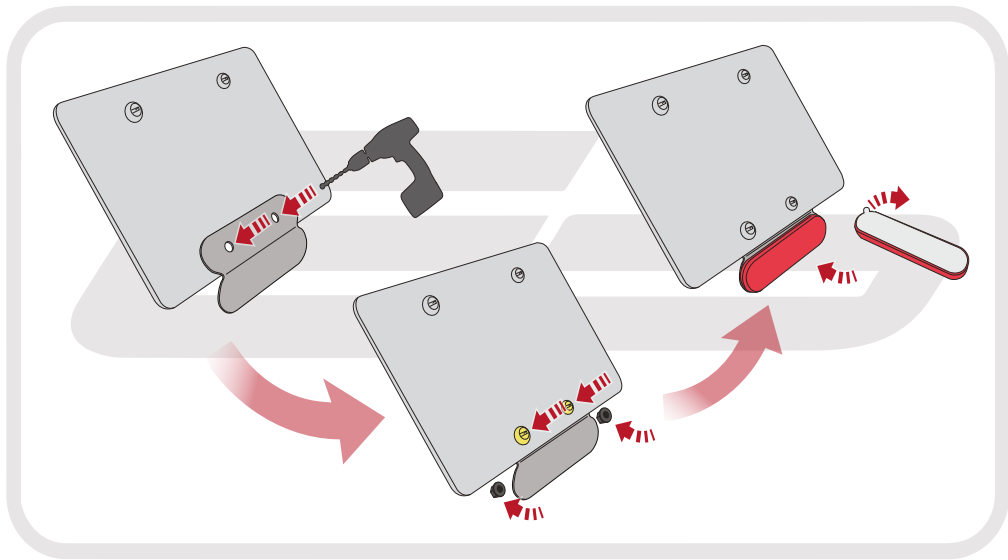



ESSENTIAL CHECKS

After installation of your tail tidy ensure that the licence plate does not contact the rear tyre when suspension is fully compressed.

Ensure all electrics including indicators, tail light, brake light and licence plate light lights are working correctly before riding the motorcycle.

It is recommended that periodic inspections are made to ensure that all fixings are fully tightend.



EVOTECH®
P E R F O R M A N C E

www.evotech-performance.com